

HESSAPP

VDM SERIES



Vertical Turning Centers



VDM – The Powerful Vertical Turning Center for a Powerful Industry

Know-how

You provide us with a complex workpiece or process, we develop the appropriate system solution (including clamping devices, tools and control system) that meet your individual demands.

Fields of applications

- ▶ Small to big part sizes (depends on machine type)
- ▶ Fully automated production including process monitoring (optional)
- ▶ Heavy machining
- ▶ Hard turning and super finishing

Advantages

- ▶ Precise and secure workpiece clamping utilizing workpiece weight
- ▶ Highest accuracy through the thermally-symmetric design of the spindle housing with closed circuit oil lubrication
- ▶ Extremely rigid machine base
- ▶ High flexibility for an optimal solution of complex turning tasks
- ▶ Many options
- ▶ Ergonomically convenient for operating and easy access to the work zone
- ▶ Optimal chip management through 45° angle of the machine base
- ▶ Machine bed available as mineral casting



VDM 550 / VDM 1000 / VDM 1600 / VDM 2000

Technologies

- ▶ Turning
- ▶ Drilling
- ▶ Milling
- ▶ Grinding
- ▶ Hobbing
- ▶ Hardturning

Industries

- ▶ General machining
- ▶ Aerospace
- ▶ Railway
- ▶ Wind energy
- ▶ Commercial vehicles

Extract from the workpiece range



Bearing ring



Gear wheel



Truck hub



Railway wheel



Flange



VDM Modular System

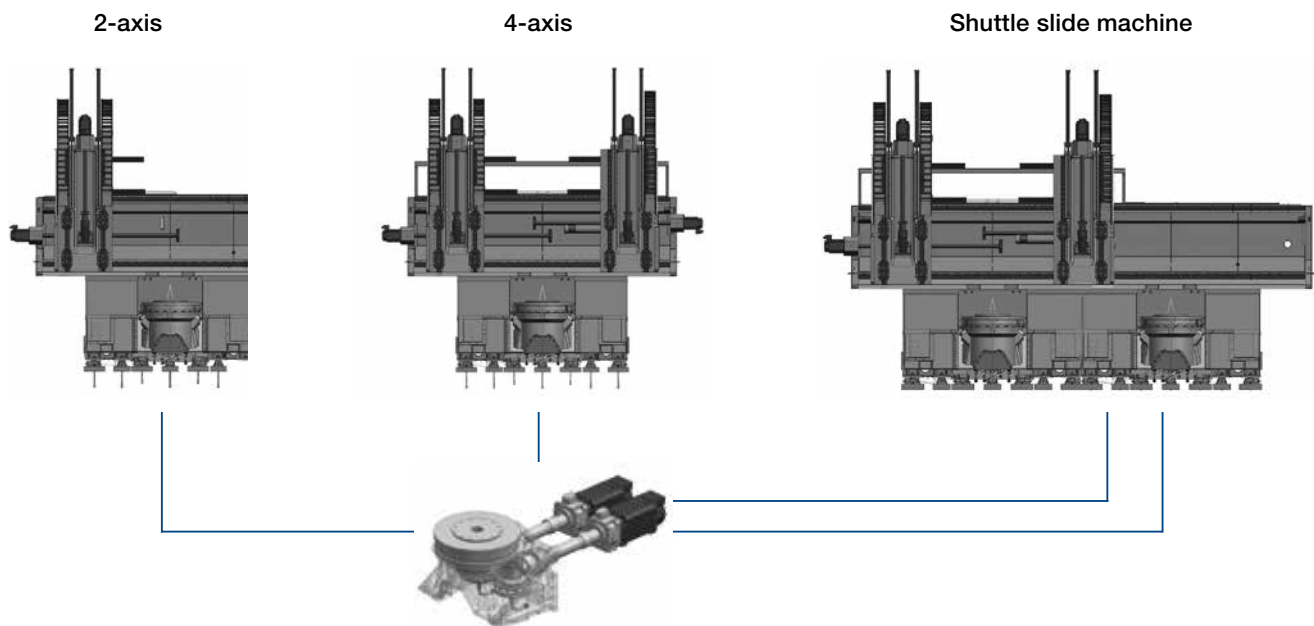

Headstock with parallel drive

- ▶ Integrated C-axis
- ▶ Dual drive in master/slave design for backlash-free positioning



Tool turret

- ▶ With or without live tools
- ▶ Torque max. 100 Nm
- ▶ Speed 3000 U/min
- ▶ Modular tooling systems or VDI 60/80



Y-Axis with B-Axis

- ▶ Y-Travel +/- 150 mm
- ▶ Torque max. 380 Nm
- ▶ Swivel angle +/- 105



Tool holder

- ▶ Torque max. 380 Nm for static and rotating tools
- ▶ HSK 63/100/Capto C6/C8



Drilling- and milling unit

Machine Models

VDM 550/800/1000/1600/2000

Categories applied for machine designation

VDM XXXX-11

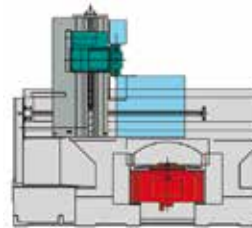
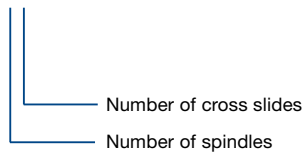

2-axis with tool turret

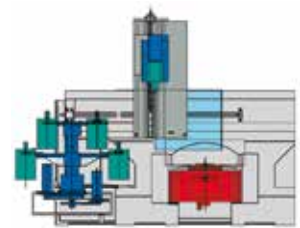

2-axis with tool changer

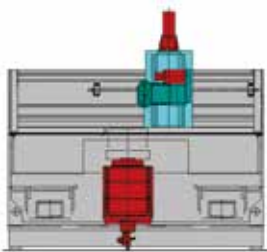

VDM XXXX-11

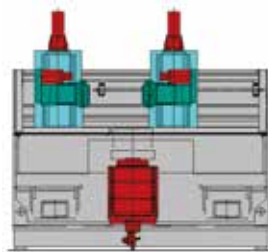

VDM XXXX-12

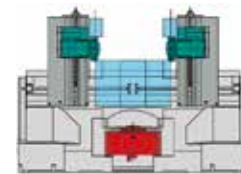

4-axis with tool turret

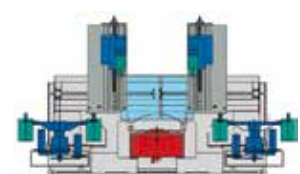

4-axis with tool changer

Separate work zone for part loading during machining

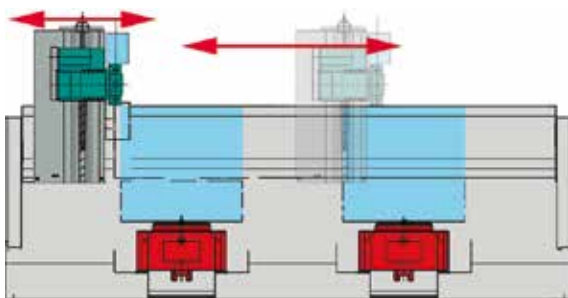

VDM XXXX-21: Shuttle slide machine (slide moves across work area)

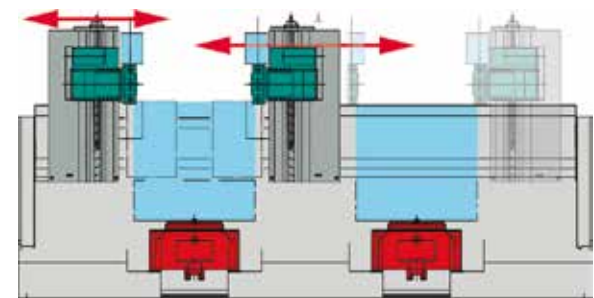

VDM XXXX-22: Shuttle slide machine (both slides move across work area)

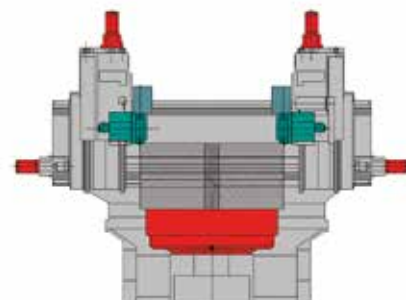

VDM XXXX-12/XXXX-12: 4-axes with turret and tool magazine

VDM 550



VDM 550 G

- ▶ Compact VDM for workpieces up to 680 mm swing diameter
- ▶ The huge work zone of the VDM 550 facilitates retooling at the clamping device and the turret
- ▶ Multiple options through integration of grinding, milling or drilling modules

Performance and flexibility features:

- ▶ powerful motorized spindles
- ▶ high axis speeds
- ▶ configuration of machine with modular system
- ▶ variable chip conveyor and cooling systems (high pressure cooling)
- ▶ variety of tools and tool holder systems
- ▶ user-friendly ergonomics
- ▶ Versions: VDM 550 T (Turning), VDM 550 TM (Turn-Mill), VDM 550 G (Grinding)

Technical Data

VDM 550		
Work Zone		
Turning diameter max.	mm	600
Swing diameter max.	mm	680
Workpiece height incl. clamping device	mm	600



Gear wheel clamped on a VDM 550

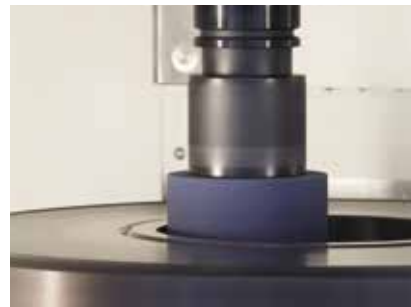

Grinding device



Hard machining



Tool Turret

VDM 800 / 1000



VDM 1000

- ▶ New generation of our vertical turning centers for 5-axis machining with integrated B- and Y-axes
- ▶ Indexing B-axis to hold static and rotating tools
- ▶ Exact positioning due to headstock with integrated C axis
- ▶ Modular tool system (HSK 63/100, Capto C6/8 and VDI 60) for varying customer requirements

Performance and flexibility features:

- ▶ powerful geared spindle or parallel drive
- ▶ 5-axis machining with optional B- and Y-axes
- ▶ configuration of machine with modular system
- ▶ variable chip conveyor and cooling systems (high pressure cooling)
- ▶ variety of different tools and tool holding systems
- ▶ quick tool change offered by a variety of systems (chain-type, magazine-type and disk-type systems)
- ▶ different expansion stages up to a shuttle slide machine
- ▶ easy access for manual crane loading
- ▶ automation via gantry or pallet changer
- ▶ Versions: VDM 1000 T (Turning), VDM 1000 TM (Turn-Mill), VDM 1000 G (Grinding)

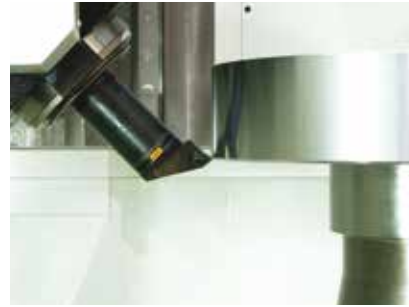

B-Axis



5-Axis Machining

Technical Data

		VDM 800	VDM 1000
Work Zone			
Turning diameter max.	mm	800	1150
Swing diameter max.	mm	900	1450
Workpiece height incl. clamping device	mm	750	1000

VDM 1600



VDM 1600

- ▶ Proven railway wheel manufacturing machine
- ▶ Tool turret includes an automatic disk-type tool changing system
- ▶ Performance features up to 54 000 Nm and 170 kW
- ▶ For manual and automatic loading

Performance and flexibility features:

- ▶ powerful geared spindle three-phase drive
- ▶ double slide version with one support for turning and milling via motorized spindle
- ▶ configuration of machine with modular system
- ▶ variable chip conveyor and cooling systems (high pressure cooling)
- ▶ variety of tools and tool holding systems
- ▶ quick tool change offered by a variety of systems (chain-type, magazine-type and disk-type systems)
- ▶ different expansion stages up to a shuttle slide machine, also known as jump slide machine VDM XXXX-22
- ▶ Versions: VDM 1600 T (Turning), VDM 1600 TM (Turn-Mill) und VDM 1600 G (Grinding)

Technical Data

VDM 1600

Work Zone

Turning diameter max.	mm	1600
Swing diameter max.	mm	1800
Workpiece height incl. clamping device	mm	900



VDM-machine with B-axis and tool carrier



4-axis Machining



Suitable for crane loading

VDM 2000



VDM 2000

- ▶ 4-axis machining for more efficiency
- ▶ External X- and Z- drives for maximum safety, the problems caused through chips or cooling can be reduced to a minimum
- ▶ The mineral casting machine bed ensures highest dampening

Performance and flexibility features:

- ▶ powerful geared spindle
- ▶ configuration of machine with modular system
- ▶ variable chip conveyor and cooling systems (high pressure cooling)
- ▶ variety of tools and tool holding systems
- ▶ quick tool change offered by a variety of systems (chain-type, magazine-type and disk-type systems)
- ▶ Versions: VDM 2000 T (Turning), VDM 2000 TM (Turn-Mill) und VDM 2000 G (Grinding)



Mineral casting machine bed



Clamping Unit



Clamping Unit



Machining of a planetary carrier

Technical Data

VDM 2000

Work Zone

Turning diameter max.	mm	1900
Swing diameter max.	mm	1950
Workpiece height incl. clamping device	mm	830

Standard Options

1 Siemens 840 D control system with

- ▶ optimal features, adjustable and expandable to suit the application
- ▶ appropriate tool management
- ▶ systematic service diagnosis

2 Ergonomics

- ▶ Excellent accessibility to workpieces and tools
- ▶ Excellent visibility of the machining process
- ▶ Trouble-free access for maintenance
- ▶ Optimal chip management through 45° angle of the machine base

3 Z-slide

Generously designed vertical slides absorb forces occurring during heavy duty machining such as railway wheel machining or alloys such as Inconel and titanium.

4 Chip conveyor

- ▶ With integrated coolant system
- ▶ High discharge of chips
- ▶ High pressure cooling of more than 120 bar as option

5 Driven tools

Turning, drilling, milling and tapping in only one clamping position offers the best machining quality, as it is not necessary to set up the workpieces between the different machining processes. In addition, fewer clamping fixtures are required.

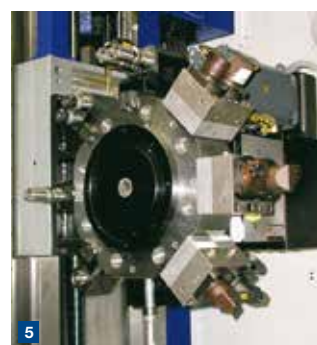

Disk turret with eight tool holders and driven tools

Machine bed

- ▶ Mineral casting or weldment
- ▶ Optimized guidance design
- ▶ Linear roller guides
- ▶ Linear measuring system in all axes
- ▶ Utilization of the latest casting technology in conjunction with FEA provides a machine base with optimum rigidity and stability without the need for additional anchoring of foundation

Headstock

The two-level gearing unit ensures high torque, also during four-axis machining. The headstock assures high accuracy through its thermally symmetric design with circulating oil lubricant.

Headstock with parallel drive

- ▶ Integrated C-axis
- ▶ Dual drive in master/slave design for backlash-free positioning

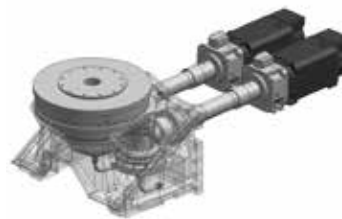
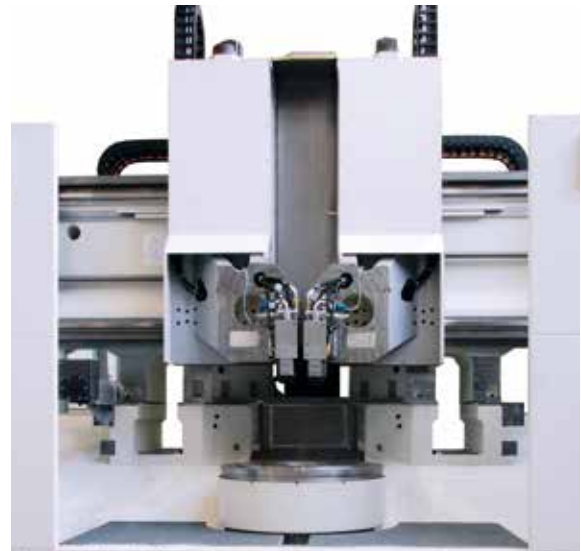

Automation

For the machining of larger parts it is getting more and more important today to reduce unproductive idle times and to increase productivity. We provide different approaches and solutions for the automation machining parts up to 2000 kg and eliminating manual part loading and unloading. This leads to high efficiency and repeat accuracy which is further increased by the integration of additional options such as

turning stations, camera recognition and measuring systems. Benefit from our know-how and experience. One of the core competencies of our company, Hessapp has provided our customers with complete automation solutions for more than 60 years.

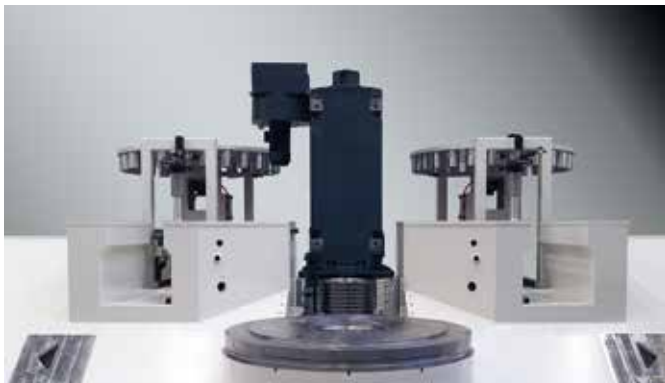

Double disk magazine with quick change shuttle, positioned at the back of the machine and accessible from a single point



Pallet system with zero-point clamping

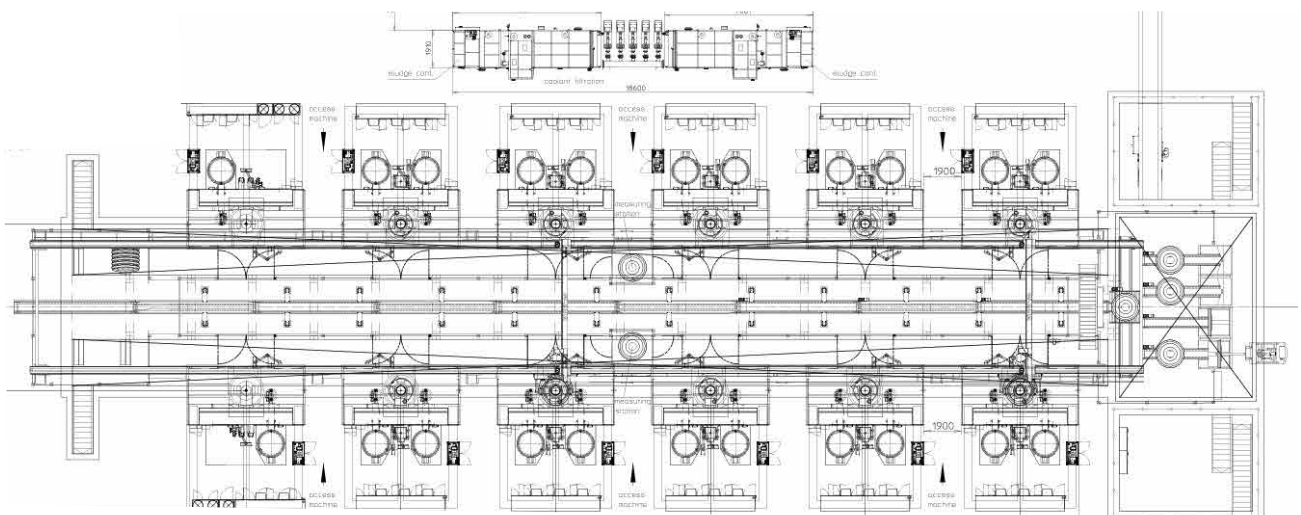

Turnkey system for railway wheel machining on Hessapp VDM vertical turning machines

Technical Data

Machine type	VDM	550	800	1000	1600	2000
Work area						
Turning diameter max.	mm	600	800	1150	1600	1900
Swing diameter max.	mm	680	900	1450	1800	1950
Workpiece height incl. clamping device	mm	600	750	1000	900	830
Feed rate/rapid traverse						
Rapid traverse Z-axis	m/min	30	20	20	20	20
Rapid traverse X-axis	m/min	60	25	25	20	20
Main spindle						
Diameter front bearing	mm	180	240	527	800	800
Spindle flange	DIN	55026	55026	6353	6353	6353
Spindle head	size	A11	A15	ZA 520	ZA 1000	ZA 1000
Main drive						
Power max. (40% duty cycle)	kW	80	160	84	165	165
Torque max. (40% duty cycle)	Nm	1150	6370	25 877	49 500	49 500
Speed max.	rpm	2800	1200	630	400	400
Tool system (option: modular)						
Stations	number	disc	disc	disc	disc	disc
Tool holders (DIN 69880)	ø mm	12	8	8	8	8
Option Y-Axis		50	60	60	60	60
		x	x	x	x	x
Machine foot print						
Dimensions L x B x H	m	3.85 x 2.65 x 4.2	5.0 x 3.5 x 4.1	7.0 x 3.5 x 4.1	8.8 x 5.4 x 4.6	8.8 x 5.4 x 4.6
Weight	kg	16 000	32 000	35 000	42 000	42 000

Technical data subject to change



VDM 550 – 2000

Service for all Brands and Legacy Brands of FFG Werke GmbH



FFG 24/7 Service and Support: www.ffg-werke.com/24x7

VDF BOEHRINGER



Horizontal turning machines

Service Center Uhingen
Stuttgarter Strasse 169, 73066 Uhingen
Tel.: +49 800 000 5639

HESSAPP



Vertical turning machines

Service Center Taunusstein
Aarstrasse 157, 65232 Taunusstein
Tel.: +49 6128 243 260

HÜLLER HILLE
DIEDESHEIM

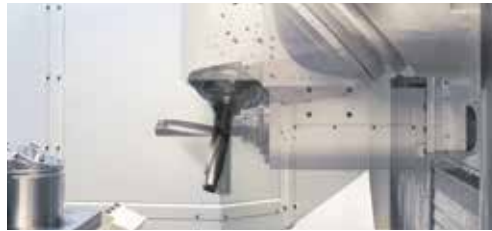

Horizontal machining centers

Service Center Mosbach
Steige 61, 74821 Mosbach
Tel.: +49 6261 66 123

Honsberg



Transfer lines, special machines

Service Center North/West
Stefansbecke 30, 45549 Sprockhoevel
Tel.: +49 2339 9278 0

MODUL



Gear manufacturing

Service Center Chemnitz
Marienberger Strasse 17, 09125 Chemnitz
Tel.: +49 371 576 386

WITZIG & FRANK



Multi-way rotary transfer machines, multi-spindle, multi-station machining centers

Service Center Offenburg
Am Holderstock 2, 77652 Offenburg
Tel.: +49 781 289 1121

Service and support

- ▶ Commissioning
- ▶ Maintenance and inspections
- ▶ Repair service
- ▶ Spindle service
- ▶ Overhaul and retrofit
- ▶ Used machines
- ▶ Service contracts
- ▶ Machine relocation



Process and production optimization

- ▶ Process optimization
- ▶ Programming
- ▶ Software: machine data acquisition, diagnosis, condition monitoring, energy management, virtual machine

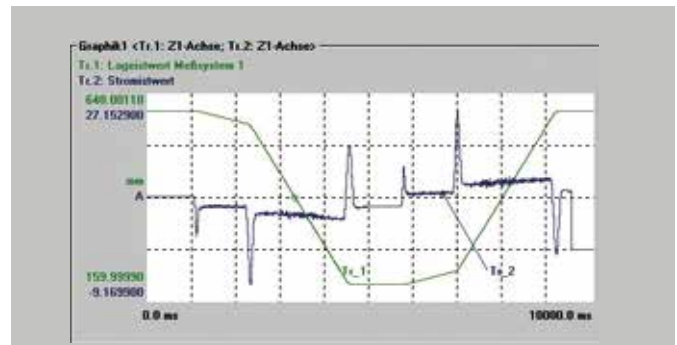
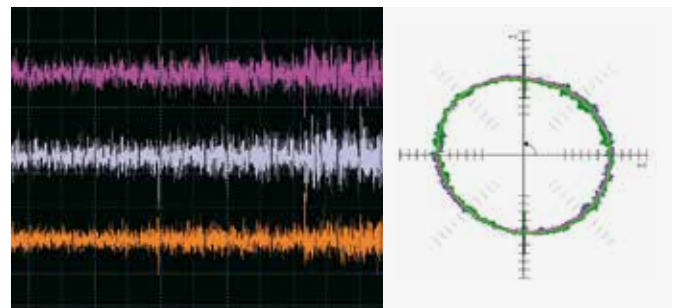

Machine condition monitoring "Finger print" via vibration analysis, ballbar test and trace measurement.

Spare parts

- ▶ 24/7 delivery
- ▶ Central warehouse
- ▶ Individual service concepts



Training

- ▶ Operator training
- ▶ Maintenance training (mechanical, electrical)
- ▶ Programming training



VDF BOEHRINGER

HÜLLER HILLE
DIEDESHEIM

HESSAPP



Honsberg

WITZIG & FRANK

FFG Werke GmbH offers a broad range of turning, milling, and gear manufacturing technology, based on the knowhow of the renowned machine tool brands VDF Boehringer, Hüller Hille, Hessapp, Honsberg, Modul and Witzig & Frank. These brands are well known as reliable and innovative equipment suppliers for the automotive and truck, machine building, general machining, railway, aerospace, energy and heavy engineering industries. The company has a global footprint, which is enhanced by a network of strong sales & service partners. While being an independent group member, FFG Werke GmbH benefits from the strengths and opportunities of the global Fair Friend Group. The brand FFG Europe stands for premium technology within FFG. Apart from the German brands, it comprises the Italian manufacturers Jobs, Sachman, Rambaudi and Sigma.

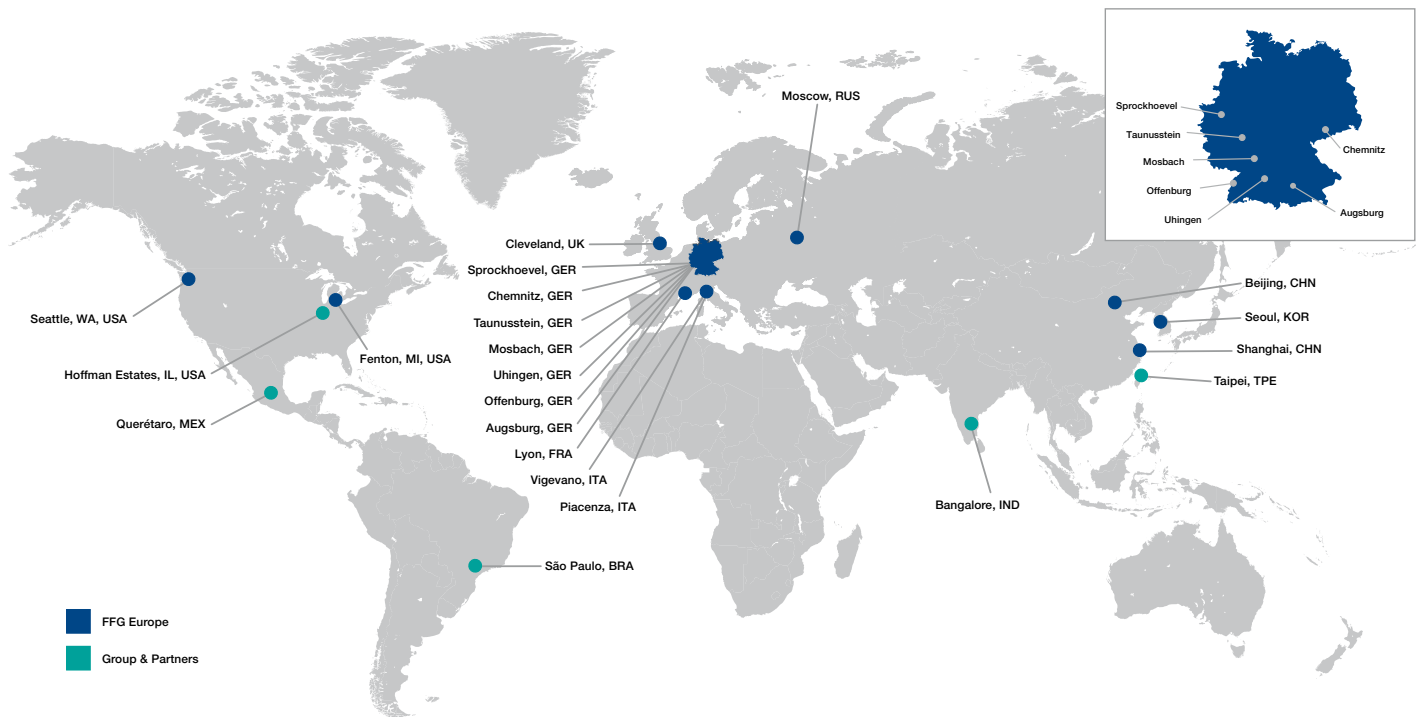

Location Taunusstein

Aarstrasse 157
65232 Taunusstein-Hahn
Tel. +49 61 28 243-0
Fax +49 61 28 243-111

FFG Werke GmbH

info@ffg-werke.com

www.ffc-werke.com



FFG 24/7 Service and Support: www.ffc-werke.com/24x7



Made in Germany since 1789